

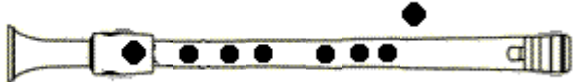











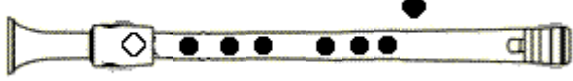

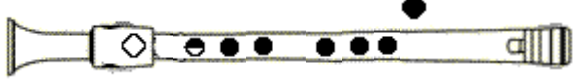

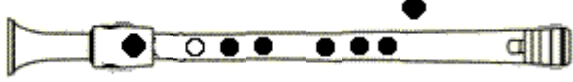
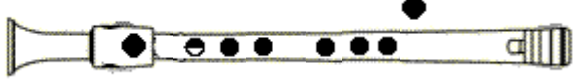
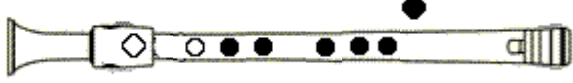

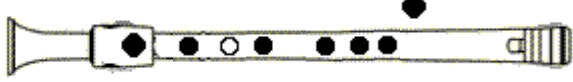

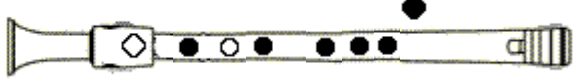
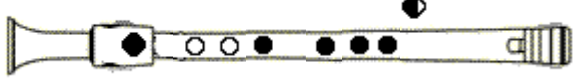
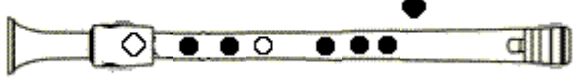

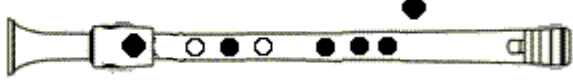
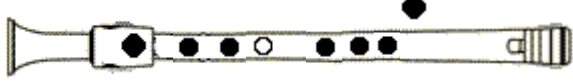
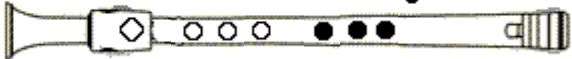

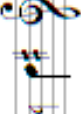



Dedilhados para a flauta doce, de Blocki

dó 1ª oitava			dó 1ª oitava
dó#/réb 1ª oitava			dó#/réb 1ª oitava
ré 1ª oitava			ré 1ª oitava
ré#/mib 1ª oitava			ré#/mib 1ª oitava
			
			
mi 1ª oitava			mi 1ª oitava
fá 1ª oitava			fá 1ª oitava
			
			
fá#/solb 1ª oitava			fá#/solb 1ª oitava
			
			

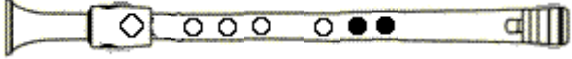
-- Dedilhado renascentista -- Soprano

-- Dedilhado renascentista -- Soprano

<p>sol 1ª oitava</p>			 <p>sol 1ª oitava</p>
<p>sol#/láb 1ª oitava</p>			
			
			
			
			
			
			
			
			
<p>lá 1ª oitava</p>			
			
<p>lá#/sib 1ª oitava</p>			



-- Dedilhado renascentista -- Soprano

3 (9)

<p>si 1ª oitava</p>		
<p>dó 2ª oitava</p>		
<p>dó#/réb 2ª oitava</p>		

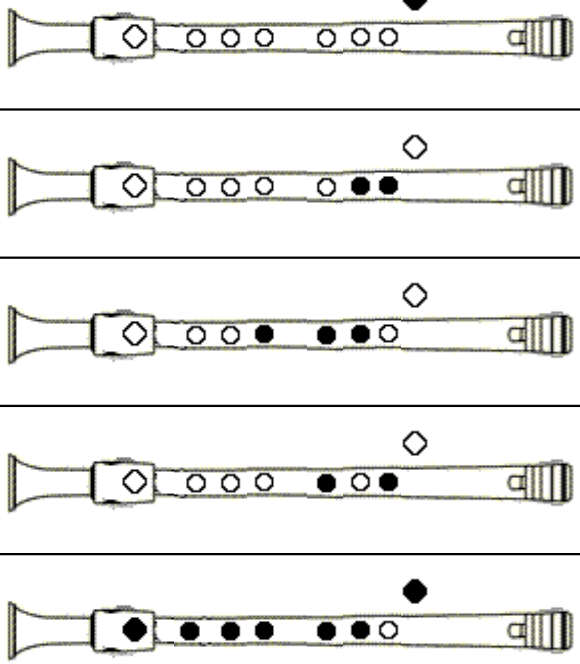
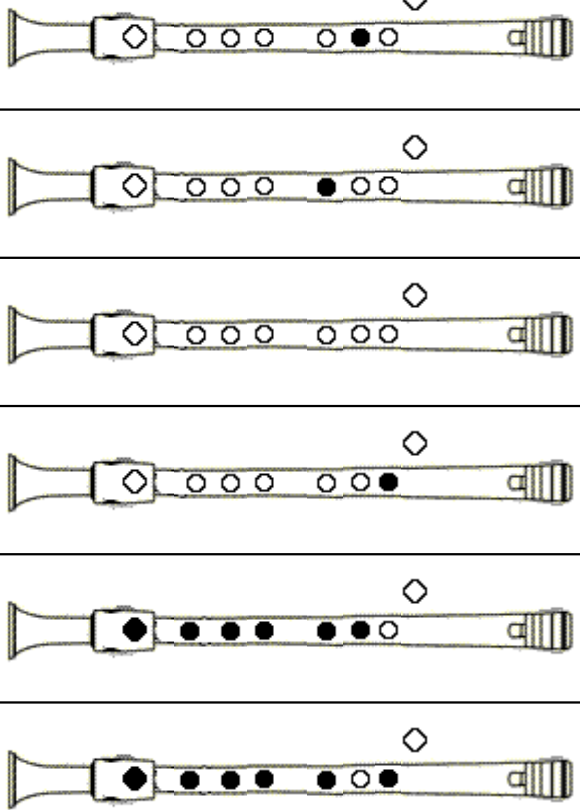
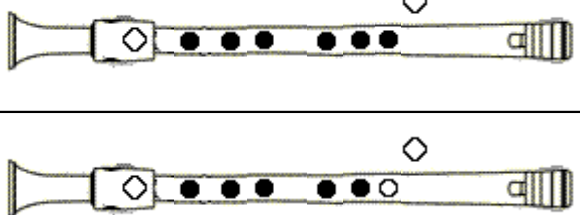

-- Dedilhado renascentista -- Soprano

4 (9)



	<p>ré 2ª oitava</p> 	<p>ré#/mib 2ª oitava</p> 
		
	<p>ré 2ª oitava</p>	<p>ré#/mib 2ª oitava</p>

-- Dedilhado renascentista -- Soprano

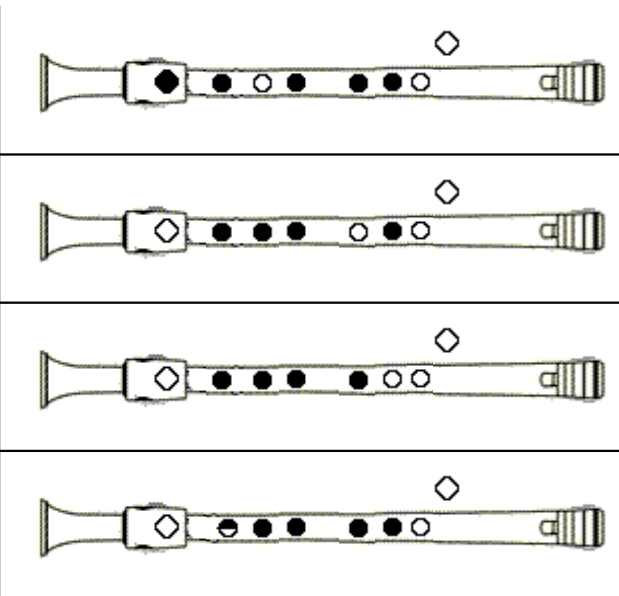
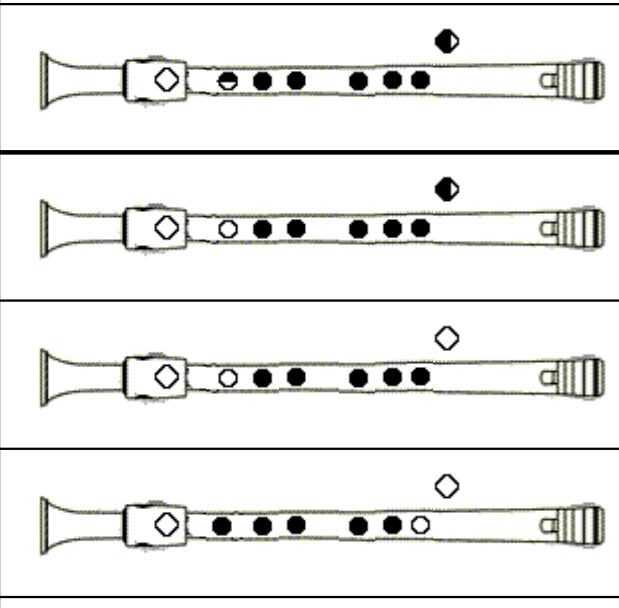
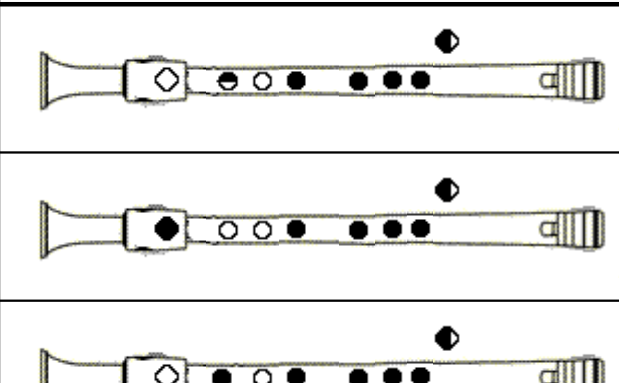
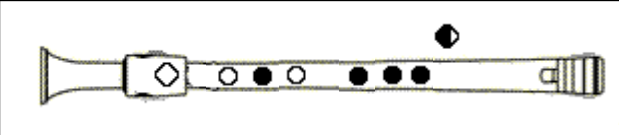

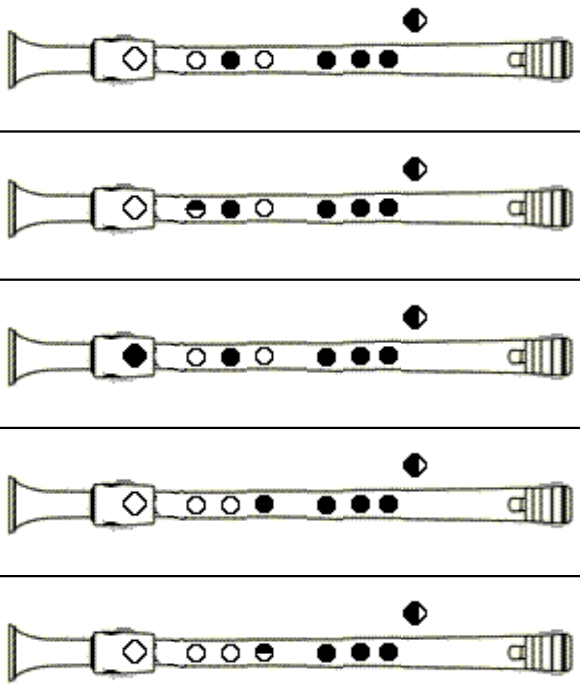
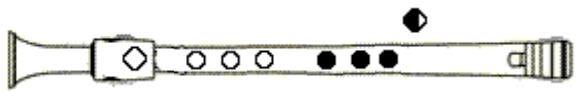
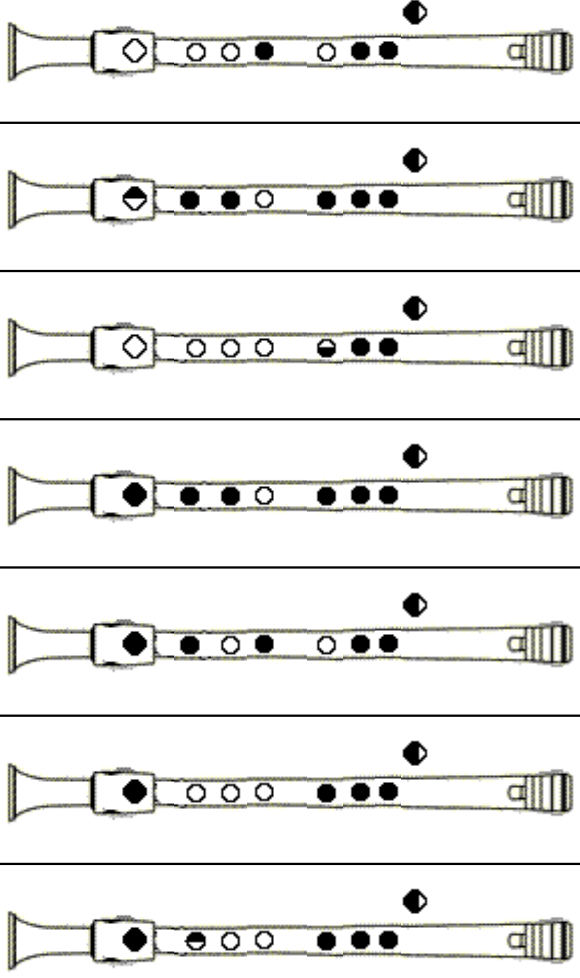

5 (9)

	<p>mi 2ª oitava</p> 	<p>mi 2ª oitava</p> 	<p>fá#/solb 2ª oitava</p> 
			

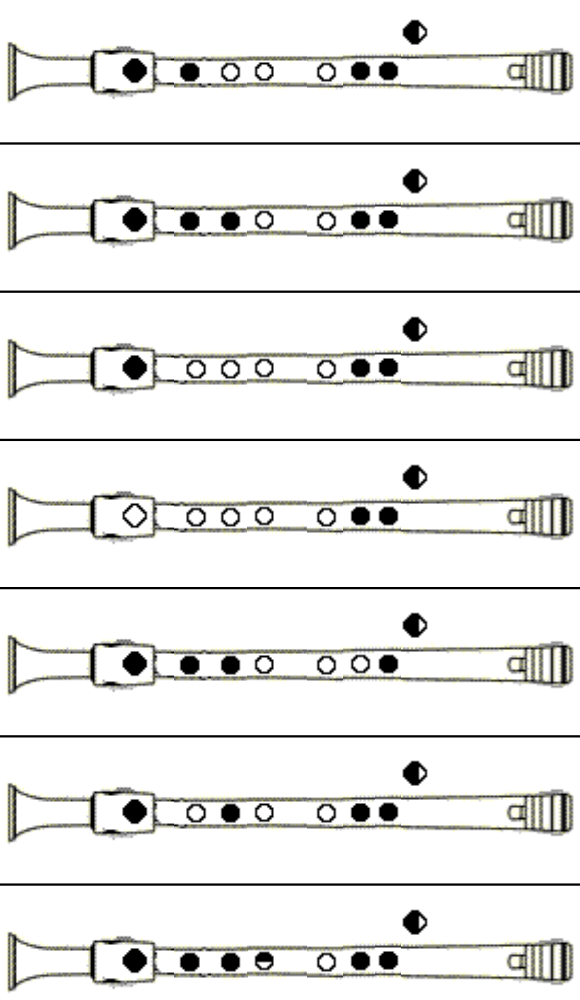

-- Dedilhado renascentista -- Soprano

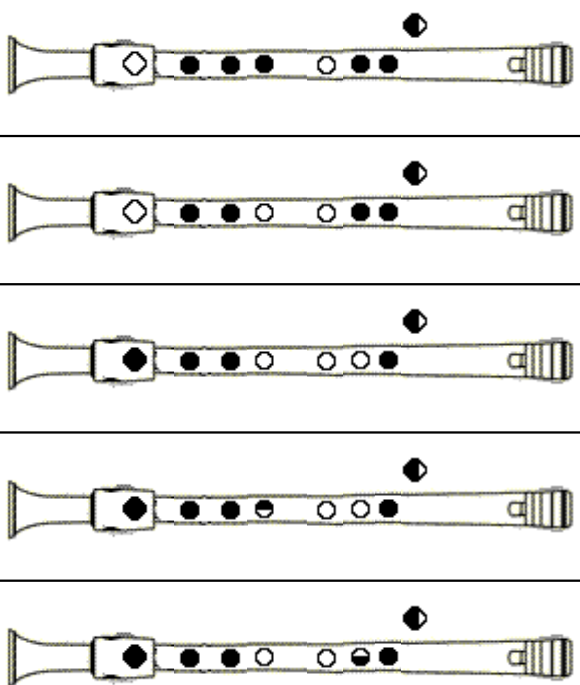
	<p>sol 2ª oitava</p> 	<p>sol#/láb 2ª Oitava</p> 
		
	<p>sol 2ª oitava</p>	<p>sol#/láb 2ª oitava</p>

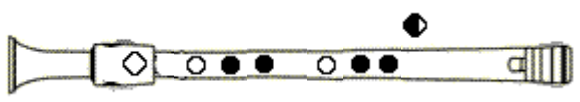
-- Dedilhado renascentista -- Soprano

<p>lá 2ª oitava</p>		
<p>lá#/sib 2ª oitava</p>		 <p data-bbox="263 1489 319 1624" style="writing-mode: vertical-rl; transform: rotate(180deg);">apenas para legato</p>
<p>si 2ª oitava</p>		

-- Dedilhado renascentista -- Soprano

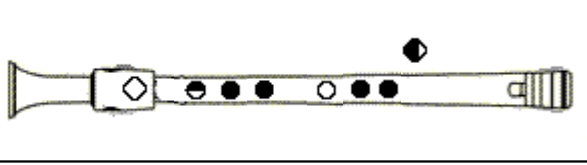
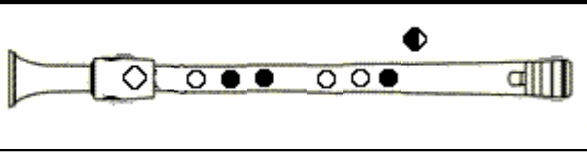
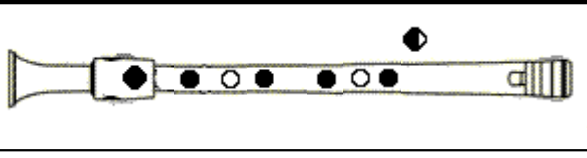
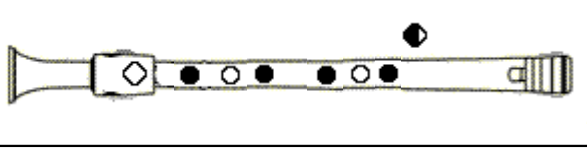
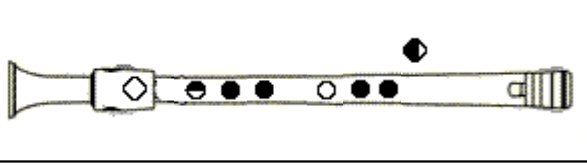
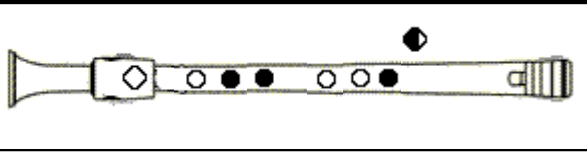
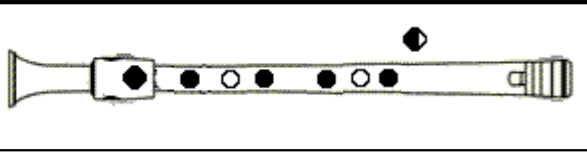
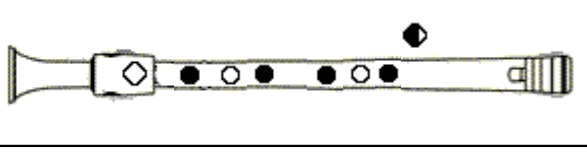
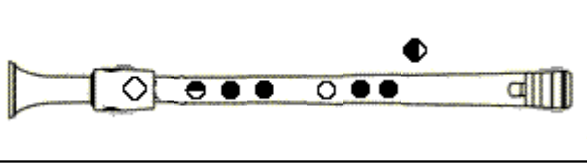
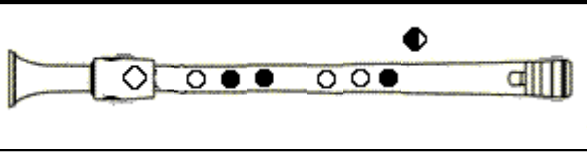
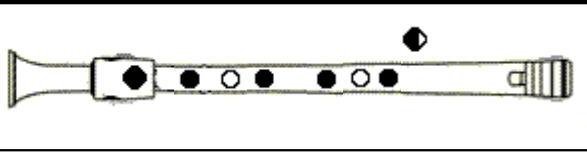
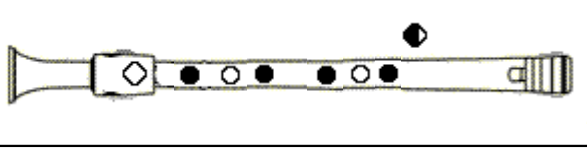
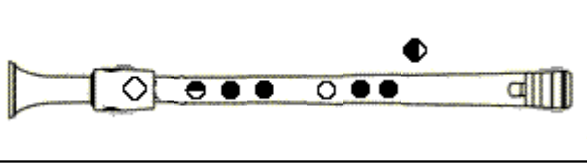
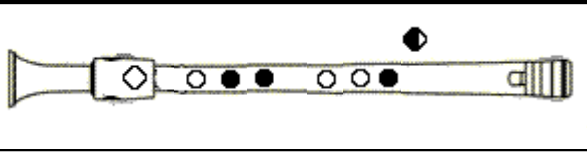
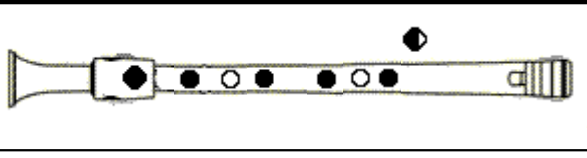
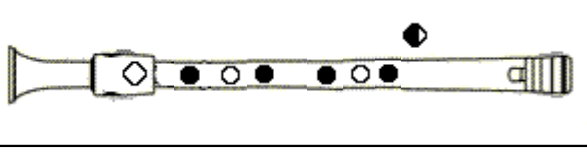
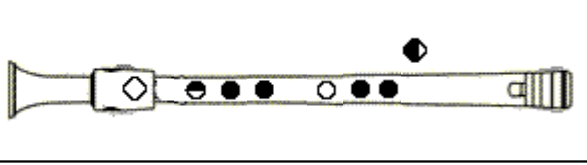
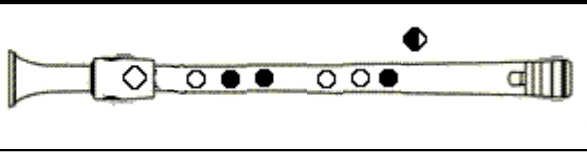
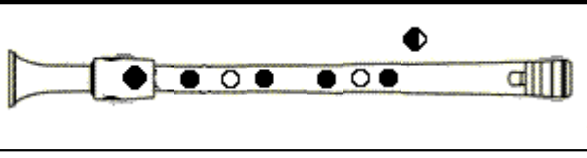
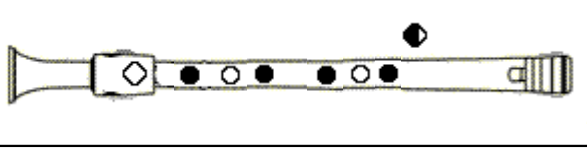
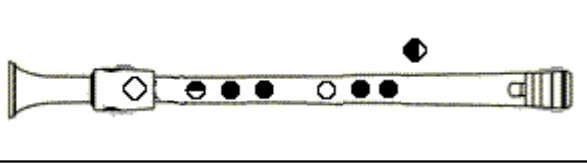
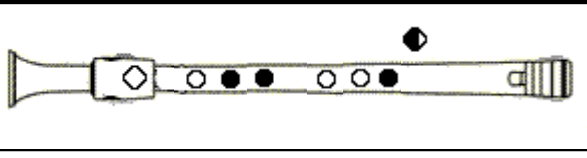
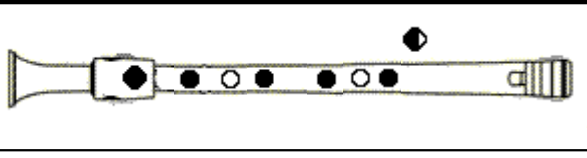
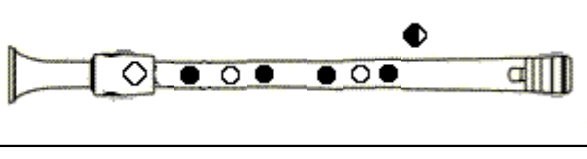
	<p>dó 3ª oitava</p> 	<p>dó#/réb 3ª oitava</p> 	<p>ré 3ª oitava</p> 	
				
				
				
				
				
				

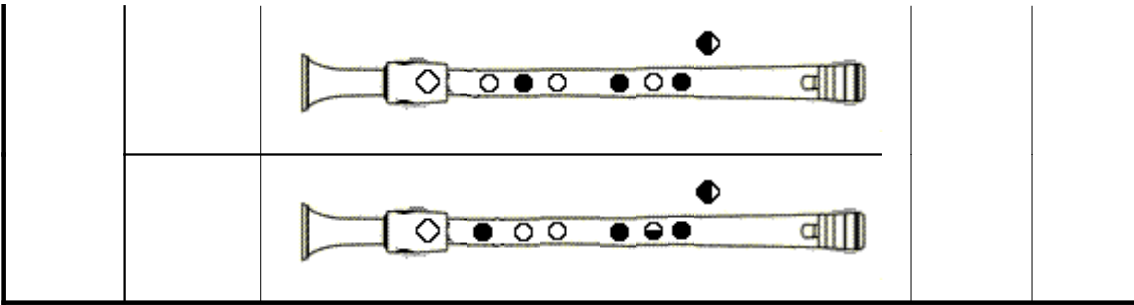

>>> O primeiro dedilhado é o recomendado, os outros são alternativos.

(FPDF/Arial)br-2019-07-16 [74.34/t161/]